

# Determining the relationships between macro variables, financial constraints, capital structure and stock returns based on expert opinion and fuzzy interpretive structural modeling approach

Masoume Ebrahimi<sup>a</sup>, Hossein Panahian<sup>a,\*</sup>, Hasan Godrati<sup>a</sup>, Mohsen Rasoulian<sup>b</sup>

<sup>a</sup>Department of Accounting and Management, Kashan Branch, Islamic Azad University, Kashan, Iran

<sup>b</sup>Department of Production and Operations Management, Kashan Branch, Islamic Azad University, Kashan, Iran

(Communicated by Javad Vahidi)

---

## Abstract

The purpose of this research is to determine the relationships between macro variables, financial constraints, capital structure and stock returns based on expert opinion polls and a fuzzy interpretive structural modeling approach. The statistical population of this research includes experts and experts of the Tehran Stock Exchange Organization, 10 experts and 384 experts were randomly selected as the research sample. In order to analyze the opinions of experts, firstly, the fuzzy Delphi method and structural equations to evaluate the selected macroeconomic variables, financial constraints and their effect on the return and capital structure and the active companies of the companies accepted in the Tehran Stock Exchange, and the fuzzy Dimetal method for Prioritizing indicators and monitoring factors were used, and structural explanatory equations were used to examine the relationships between variables. The findings of this research included several parts, in the first part, macroeconomic variables were identified and introduced using the Delphi technique, then the relationships between the main variables of the research were investigated using the fuzzy interpretive structural equation method, and finally the investment indicators and in Continued liquidity and financial constraints were identified as influential indicators. In the third part of the data analysis of this research, the impact of macroeconomic variables and financial constraints on capital structure and stock returns was investigated, which showed that financial constraints have an effect on the intensity of the economic production gap on capital structure, stock returns, and company size on stock returns.

Keywords: macro variables, financial constraints, capital structure, stock returns  
2020 MSC: 91B64

---

## 1 Introduction

Due to the past period, stock markets have been used over the years as a means of mobilizing funds by private and public entities and are prominent indicators for predicting economic growth. Stock markets act as financial

---

\*Corresponding author

Email addresses: [ebrahimimasomeh54@yahoo.com](mailto:ebrahimimasomeh54@yahoo.com) (Masoume Ebrahimi), [panahian@yahoo.com](mailto:panahian@yahoo.com) (Hossein Panahian), [h.godrati@iaukashan.ac.ir](mailto:h.godrati@iaukashan.ac.ir) (Hasan Godrati), [mohras@gmail.com](mailto:mohras@gmail.com) (Mohsen Rasoulian)

intermediaries and are important sources of capital and liquidity because they provide a platform for a secondary market to trade listed securities. As an integral part of financial systems, stock markets play an important role in financing corporate entities in Africa. The poor performance of financial markets is sufficient justification to explain why most developing countries remain poor. Despite this, developing countries have taken great strides towards creating well-functioning financial markets. Capital market development has become the focus of governments, operators and market regulators to mobilize long-term capital for businesses and the government. If countries have a developed and rooted financial market that plays an effective role in production, they can enjoy benefits such as risk reduction, availability of cheap financial resources, etc. [6].

During the past years, various researches have investigated the factors affecting investment risk and various variables such as market factor, size and book value have been introduced as risk factors. Financial limitation is one of the other factors whose role on stock returns has been noted in the financial literature, and there are multiple evidences in the field of the effect of financial limitation on stock returns in the literature [20].

Financing plays a fundamental role in firm innovation and represents a central research topic in financial management and innovation [11, 12]. Access to financial resources allows organizations to strategically invest in the factors of production necessary to develop competitive advantages. However, companies often face financial constraints to access the credit market and this limits their development [24]. Innovation often depends on the availability of cash, so financial constraints can be a serious obstacle to drive innovative activities of the company. These decisions always have financial implications and therefore, to be effective, entrepreneurs must have a wealth of financial information. Financial information is one of the most relevant skills for the development of companies by minimizing the obstacles in the credit market [16]. Although there is a large literature on the relationship between financing and innovation, the role of financial information of corporate managers has been less investigated. Various studies show that people with more financial information are more likely to participate in a wide range of recommended financial actions. Therefore, financial information is an important tool for managing business finances. However, financing is one of the main problems that various companies face in relation to their activities [13] and one of the reasons is the lack of financial skills of the owner or manager. For this reason, it is important to analyze the mechanisms that managers of different companies have to improve access to financial resources and the ability to carry out their activities. Previous research shows that managers with good financial information participate more actively in financial markets by reducing informational constraints and achieving more favorable access to credit. Therefore, financial information may be an important precursor to reducing financial constraints [12].

Capital structure and stock returns are topics that have received the most attention in the field of financial management and financial markets. One of the main duties of financial managers in companies is to determine the best combination of financial resources of the company, or in other words, the capital structure. Decisions regarding the capital structure should be in line with increasing the value of the company. In order to maximize the value of the company, it is necessary to decide on the best investments and their combination, as well as how to finance them. Financial provision can be through using debt and creating leverage, or through contributions from shareholders [5]. Existence of debt in the financial structure of companies, on the one hand, due to tax effects, increases the accounting profit and, as a result, the increase in stock returns, and on the other hand, the increase in interest costs and the possibility of not paying debts when due, increases the financial risk and, as a result, decreases The market price of the stock has increased, and as a result, the yield of the stock also decreases. Therefore, one of the main concerns of financial managers is determining the optimal combination of capital structure [14]. Today, the ranking of companies in terms of credit depends to a large extent on their capital structure, and in fact, the basis of production and provision of services depends on the way of providing and consuming financial funds. On the other hand, the capital structure of each company is an early warning regarding the level of financial distress of the company, and it is necessary to pay serious attention to determining the factors affecting the efficiency of their financing in the strategic planning of companies [18].

One of the other basic criteria for making decisions in the stock market is stock returns. Stock returns alone have informational content and are used by most actual and potential investors in financial analysis and forecasting. Currently, investors can predict stock returns to some extent by creating a bridge between stock returns and other financial and non-financial information. Based on this, in the field of predicting stock returns, which is one of the desirable topics for investors and financial researchers, many efforts have been made so far to provide a model that predicts stock returns in a reliable manner. Based on the investigations, the pricing model of capital assets is the most widely used model that has been used in various fields of financial management and investment, especially the estimation of company stock returns.

In order to develop the related literature, this research focuses on the different dimensions of the effect of financial constraints on profitability, and in particular, the effect that financial constraints have on the relationship between

profitability and company size, company investment, and macroeconomic conditions; was investigated. In addition, it is investigated to what extent the financial constraint leads to common changes in the stock returns of different companies, and hence it can be used as a separate factor in multi-factor asset pricing models. In the end, the purpose of this research is to determine the relationships between macro variables, financial constraints, capital structure and stock returns based on a survey of experts and the fuzzy interpretive structural modeling approach that we have investigated.

## 2 Literature and research background

Capitalism produced large companies during periods of economic development. At first, the process of attracting capital was done through underwriting companies and banks, etc., which later came up in the stock exchange, which assumed the responsibility of redistributing the shares of these companies. The company's decision on capital policy structure has remained a matter of debate for a long time and is still unresolved. Traditionally, economists believe that capital structure results in a weighted cost of capital that is U-shaped, meaning that there is an optimal mix of debt and equity. The main idea of this research study is how companies listed in the Tehran Stock Exchange determine their optimal capital structure under different macroeconomic conditions. The right side of the balance sheet (i.e. liabilities and equity) is used to select the capital structure of companies. Therefore, companies have a list from which to consider alternative capital structures. Generally they can issue only debt or equity or a combination of both. While issuing debt, they can be issued through floating preferred stock (preferred stock is a form of equity and because of its characteristics that have similarities to debt financing, often considered in debt), warrants and "convertible bonds" finance etc. To limit this study to a reasonable limit, we will consider the decision between debt and equity. Those macroeconomic factors are considered here along with some (firm-specific) control parameters that are important to firms when choosing between debt and equity. Nevertheless, this capital structure decision is strategically important for companies. Because in this way they can achieve the goal of maximizing the shareholders' wealth. Directors appointed by the board of directors of companies are agents who act on behalf of the principals (shareholders) of the organization. Therefore, they are expected to make a smart decision about the combination of capital structure to finance their company. So, the question that arises here is how to choose the best debt-to-equity ratio for a company, and the answer lies in the phrase "the debt-to-equity ratio that maximizes the value of the company." And of course it depends on the wisdom of management. This capital structure decision is placed in the field of "financial policy" of companies. Correct and prudent decision-making regarding the choice of capital structure by financial managers leads to a positive and direct increase in the company's stock price and ultimately increases the company's market value. The research conducted so far has considered a sample of companies from developed and industrialized countries. This relationship between Iran is still in its early stages and growing. Inadequate and unavailable financial data can be the real cause of this situation in Iran.

Due to the importance of the topic, in recent years, many researches have investigated the factors affecting the capital structure and stock returns, but most of the researches have investigated the one-way causal relationship [1, 2, 3, 4, 5, 7, 9, 14, 15, 19, 22, 23]. In other words, in this research, either the effect of capital structure and other variables on stock returns has been examined, or the effect of return and other variables on capital structure has been considered. The managers' comprehensive awareness of the determining factors can help them in making optimal decisions in this field, and paying attention to the features governing the managers' financial thinking will stabilize the main position of the company in the financial markets and correct crediting by the creditor. It will become the issuer of the capital markets. Also, by considering the influencing variables, investors can make better decisions in order to obtain appropriate returns. In this regard, several similar researches inside and outside of Iran have addressed this issue, which is mentioned below.

In a research, Darvishi [10] investigated the impact of financial restrictions and financial development on the relationship between future investment and stock liquidity in companies listed on the Tehran Stock Exchange. This research is a library and analytical-causal study and is based on panel data analysis. In this research, the financial information of 119 companies admitted to the Tehran Stock Exchange during the period from 1392 to 1397 has been examined (714 companies - 6 years). Eviews software was used to analyze the results of the research. The results showed that financial constraints have an effect on the relationship between liquidity criteria (turnover rate) and future investment. Financial limitation does not affect the relationship between liquidity criteria (Amihod's illiquidity and Amiost's liquidity ratio) and future investment. Financial development has an effect on the relationship between liquidity criteria (Amihud's illiquidity) and future investment. And finally, financial development does not affect the relationship between liquidity criteria (turnover rate and Amiost's liquidity ratio) and future investment.

Pourali et al. [21] conducted a research titled the effects of macroeconomic and institutional variables on the eco-

economic growth of selected developing countries. In this research, to investigate the effect of macroeconomic indicators (international trade, human capital, physical capital, inflation and foreign debts) and institutional (a composite index consisting of the components of the right to protest and respond, political stability without violence, government effectiveness, rule of law, quality regulation and control of corruption) on economic growth in 15 selected developing countries during the period from 2006 to 2019 using panel data in the form of dynamic ordinary least squares econometric technique. The results of the estimates indicate that, among macroeconomic variables, inflation and foreign debts have a negative effect on economic growth, and international trade, human capital, and physical capital have a positive effect on economic growth. In connection with institutional variables, the combined index of institutional factors has a positive effect on economic growth.

Cuevas-Vargas et al. [8] conducted a research titled the impact of capital structure and innovation on company performance, direct and indirect effects of capital structure. The purpose of this research is to empirically examine the impact of capital structure and innovation on company performance among small and medium-sized Mexican manufacturing companies and to analyze the indirect effects of capital structure to determine the mediating effects of innovation. A quantitative approach and cross-sectional design was applied through Partial Least Square Structural Equation Modeling (PLS-SEM). A simple random sampling method and a self-administered questionnaire were used to collect data from a sample of 220 managers or business owners in the state of Aguascalientes, Mexico. The results show that capital structure has a significant effect on innovation and only has an indirect effect on company performance. Given that innovation has been shown to play a significant mediating role in this relationship, SMEs should increase their level of innovation if they want to achieve better firm performance. Therefore, decision makers should pay special attention to reinvesting their profits to increase levels of innovation and firm performance.

Mettelskaya [17] conducted a research titled correlation and regression analysis of the impact of macroeconomic factors on the capital structure of Russian companies in crisis conditions. The aim of this study is to empirically test hypotheses that show how the level of corporate leverage depends on traditional determinants during and after the financial crisis under emerging market conditions in Russia. This study deals with a large dataset of 49 public companies from 7 leading Russian economic sectors for the period 2011-2017. According to the results of correlation and regression analysis (1) the use of traditional theories of capital structure under the conditions of current financial globalization in a country with a developing economy is inefficient for the formation of an optimal capital structure (2) the formation of the company's capital structure is strongly influenced by factors It is macroeconomic that is clearly revealed during and after the crisis (3). The financial crisis has a strong impact on the capital structure of the company (4) The determining factor of stock market development has a significant impact on leverage and plays a prominent role in financial decisions after the financial crisis.

### 3 Research methodology

The current research method is based on the purpose of applied research and based on the method of data collection, it is considered a descriptive method of the survey branch. This research is practical in terms of the purpose of the research, and according to its nature and method, it is descriptive and regression type. In terms of epistemology, it is an empiricist type, its reasoning information system is inductive, and in terms of the type of study, it is an archival field study. In addition, it is placed in the field of post-event studies (use of past information) and is based on real information from the financial statements of companies admitted to the Tehran Stock Exchange and other real information that can be generalized to the entire statistical population by inductive method.

This qualitative study was conducted at the level of companies accepted in Tehran Stock Exchange and 20 document sources of authentic articles were selected as samples. For the purpose of analysis, the method of qualitative content analysis with a conventional approach was used. Based on the above variables, the following conceptual model has been drawn, which will be implemented after validation by experts, using data published by the Tehran Stock Exchange and Securities Organization.

In addition, in this research, questionnaire tools and reference to standard data (data extracted from Tehran Stock Exchange Organization) were used. The statistical population of this research includes the experts of the Tehran Stock Exchange Organization, whose number is about 10 people. Also, the statistical community of experts, which includes an unlimited number of experts of the Tehran Stock Exchange Organization. Based on this and according to the characteristics of the statistical population, the sampling of the current research was randomly selected, and the statistical sample of the organization's experts is 10 people, and the statistical sample of experts includes 384 people.

Finally, in this research, using Spss 16 and Lisrel 8.5 software, various methods of descriptive and inferential statistics have been used to analyze data and test hypotheses.

## 4 Results

In this section, after collecting and summarizing the data, we analyze the data using Lisrel 8.5 and Spss 16 software through descriptive indices and inferential statistics.

### 1. Documentary analysis

The following table shows all the identified codes according to their concepts, which are grouped in the form of categories with similar concepts with a comparative approach (Table 1, Table 2).

Table 1: Categories related to financial restrictions

Code	Categories
A1	Cash flow and short-term investment
A2	Changes in the company's liabilities and assets
A3	The ratio of the market value to the book value of the company
A4	Dividends on assets
A5	Debt-to-asset ratio
A6	Cash balance
A7	Supplying resources through internal company resources
A8	Failure to acquire new assets
A9	Failure to invest in new business activities
A10	Reduced dividend payments
A11	Maintaining a certain level of working capital
A12	The sum of operating profit and depreciation
A13	Research and development costs
A14	Change in non-cash assets

Table 2: Categories related to macroeconomic variables

Code	Categories
B1	Inflation
B2	Liquidity
B3	Consumer Price Index
B4	Importation
B5	Non-oil exports

Finally, according to the results of the research, financial restrictions and macroeconomic variables have been identified based on the following research (Table 3).

Table 3: Categories related to financial restrictions

Variable	Categories
Financial limitations	Cash flow and short-term investment
	Changes in the company's liabilities and assets
	The ratio of the market value to the book value of the company
	Dividends on assets
	Debt-to-asset ratio
	Cash balance
	Supplying resources through internal company resources
	Failure to acquire new assets
	Failure to invest in new business activities
	Reduced dividend payments
	Maintaining a certain level of working capital
	The sum of operating profit and depreciation
	Research and development costs
	Change in non-cash assets
Macro indicators	Inflation
	Liquidity
	Consumer Price Index
	Importation
	Non-oil exports

### 2. Distribution based on central indicators, dispersion and distribution shape

Data description indicators are divided into three groups of central indicators, dispersion indicators and distribution shape indicators. In this section, how the research variables are distributed based on the most important

central indices (mean), dispersion indices (variance and standard deviation) and distribution shape indices (skewness coefficient and elongation coefficient) are examined (Table 4). According to table 4, it can be seen that the lowest average value of the variable "research and development costs" and the highest value belongs to the ratio of debt to assets. Also, since the value of skewness is in the range of (-3 and +3), so it can be said that the data has a normal distribution.

Table 4: Central indicators, dispersion and distribution of questions and variables

	Minimum	Maximum	Average	Standard deviation	Variance	Skewness	Kurtosis
Cash flow and short-term investment	1	5	523/3	332/1	775/1	355/1-	182/0-
Changes in the company's liabilities and assets	1	5	794/3	084/1	177/1	854/0-	445/0-
The ratio of the market value to the book value of the company	1	5	576/3	083/1	174/1	027/1-	123/0-
Dividends on assets	1	5	542/3	0405/1	083/1	594/0-	183/0-
Debt-to-asset ratio	1	5	305/4	925/0	856/0	014/1	265/1-
cash balance	1	5	236/4	988/0	978/0	645/0	213/1-
Supplying resources through internal company resources	1	5	926/3	982/0	966/0	267/0-	657/0-
Failure to acquire new assets	1	5	121/4	910/0	830/0	418/0	895/0-
Failure to invest in new business activities	1	5	881/3	052/1	107/1	572/0-	636/0-
Reduced dividend payments	1	5	976/3	994/0	989/0	193/0-	713/0-
Maintaining a certain level of working capital	1	5	997/3	007/1	016/1	398/0	958/0-
The sum of operating profit and depreciation	1	5	915/3	976/0	953/0	241/0-	651/0-
Research and development costs	1	5	513/3	346/1	812/1	995/0-	491/0-
Change in non-cash assets	1	5	955/3	053/1	109/1	082/0-	796/0-
Financial limitations	80/1	5	876/3	619/0	384/0	299/0	745/0-
Capital Structure	1	5	907/3	878/0	771/0	332/0	826/0-
Stock returns	1	5	015/4	894/0	801/0	268/0	808/0-
Macroeconomic variables	75/1	5	642/3	657/0	432/0	616/0	554/0-

### 3. Inferential data analysis

After the descriptive analysis of the data, we proceed to the inferential analysis of the data. In inferential analysis, research hypotheses are evaluated and tested.

#### (a) Exploratory analysis of research parameters

Before performing any analysis on the collected data and statistical inference, the reliability and validity of the measurement tool should be ensured first. The reliability of the questionnaire was measured by Cronbach's alpha test and the test results showed that the used questionnaires have the necessary reliability and accuracy. In order to measure validity, there are various methods, in this research, considering that the variables of the research consist of several dimensions (components), the confirmatory factor analysis test has been used. Therefore, as stated in the third chapter, in conducting factor analysis, it must be ensured whether the available data can be used for analysis or not. In other words, Is the amount of data suitable for factor analysis or not? For this purpose, KMO index and Bartlett's test have been used. Based on these two tests, the data are suitable for factor analysis when the KMO index is greater than (0.6) and close to one and the sig of Bartlett's test is less than (0.05). The results of these tests are presented in the following tables.

According to Table 5, the value of KMO index is equal to 0.728 (more than 0.6), so the number of samples (number of respondents) is sufficient for factor analysis. Also, the sig value of Bartlett's test is smaller than 0.05; which shows that factor analysis is suitable for identifying the structure of the factor model and the assumption that the correlation matrix is known is rejected.

Table 5: KMO and Bartlett test for questionnaire questions

<b>KMO Test</b>		<b>728/0</b>
<b>Bartlett's test</b>	$\chi^2$	39/14
	Degrees of freedom	172
	Sig	000/0

In exploratory factor analysis, the principal components method was used to extract the factors and the Varimax method with Keyser normalization was used to rotate the factors. Criteria for deciding on the survival or removal of questionnaire questions from factor analysis; their share values are derived. In this way, if the extracted share value of each question is less than (0.5), we exclude that question from the factor analysis. Also, the criteria for deciding on the classification of questions, characteristic values higher than (1) and factor scores higher than (0.4) have been considered. In order to show in which factor each questionnaire question is placed, the highest factor load of that question is marked with another color in the exploratory factor analysis tables.

According to Table 6, the value of the extracted share for all questions is more than (0.5) and no question from the questionnaire needs to be left out. According to the table, 4 factors with characteristic value higher than one have been extracted, and all the questions related to this variable are placed in these 4 factors. Also, according to the factors of the questions, each of the questions have the highest factor load in the same factor that was predetermined. Therefore, each question measures exactly the same factor for which it is designed, so the questions of the questionnaire have the necessary validity.

Table 6: Matrix of factors rotated by principal component analysis method and Varimax rotation method with Keyser normalization

Questions	The first factor	The second factor	The third factor	The fourth factor	Extractive subscription
	Limitation	Macro	Yield	Structure	
Question 1	0.690				0.687
Question 2	0.743				0.704
Question 3	0.640				0.645
Question 4	0.542				0.612
Question 5	0.505				0.562
Question 6	0.580				0.520
Question 7	0.608				0.566
Question 8	0.684				0.635
Question 9	0.687				0.566
Question 10	0.606				0.594
Question 11	0.602				0.543
Question 12	0.578				0.584
Question 13	0.680				0.707
Question 14	0.735				0.683
Question 15		0.790			0.688
Question 16		0.544			0.588
Question 17		0.484			0.552
Question 18		0.676			0.657
Question 19		0.712			0.646
Question 20			0.474		0.587
Question 21			0.493		0.643
Question 22			0.499		0.677
Question 23			0.424		0.676
Question 24				0.656	0.657
Question 25				0.700	0.590
Question 26				0.734	0.555

4. Confirmatory factor analysis of research variables

In the inferential analysis, before testing the hypotheses, we should test the validity of the construct using the confirmatory factor analysis test. The suitability test in the confirmatory and path analysis, the RMSEA index, or the root mean square of the estimated error variance is less than eight percent, the index is less than three  $\frac{\chi^2}{df}$  and (GFH, CFL, IFI, NNFI) is greater than 90 percent. If the value (T-Value) of the significant coefficients of each variable is greater than 2 and less than -2, the model has a good fit, or in other words, it has a reasonable approximation of the society.

- (a) Model for measuring financial constraints

The graphs that we have given in the following section show the dimension model of financial constraints in standard and meaningful mode. As these graphs show, the membership of all investigated factors in this variable has been confirmed.

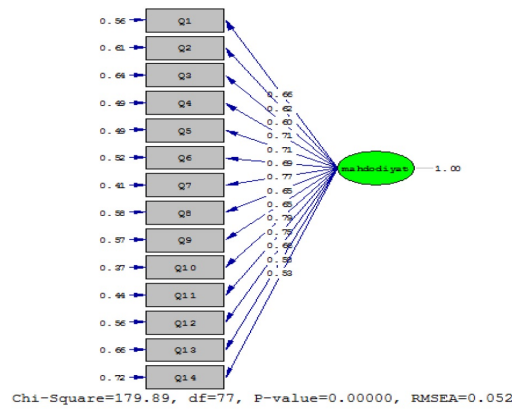

Figure 1: The model for measuring the dimensions of financial constraints using factor analysis in the standard mode

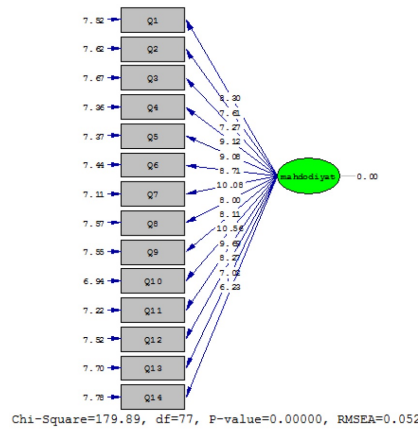

Figure 2: A model for measuring the dimensions of financial constraints using factor analysis in a meaningful state

(b) Measuring model of macroeconomic variables

The graphs that we have given in the following section show the dimension model of macroeconomic variables in standard and meaningful mode. As these graphs show, the membership of all investigated factors in this variable has been confirmed.

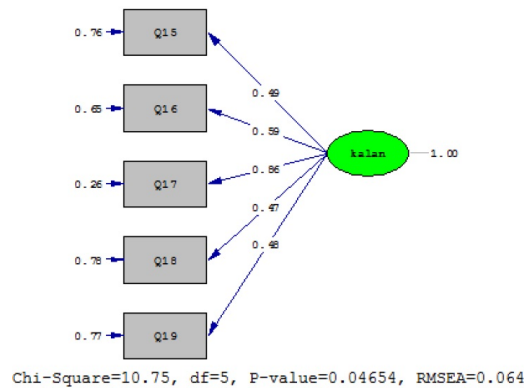

Figure 3: The model for measuring the dimensions of macroeconomic variables using factor analysis in the standard mode

(c) Capital structure measurement model



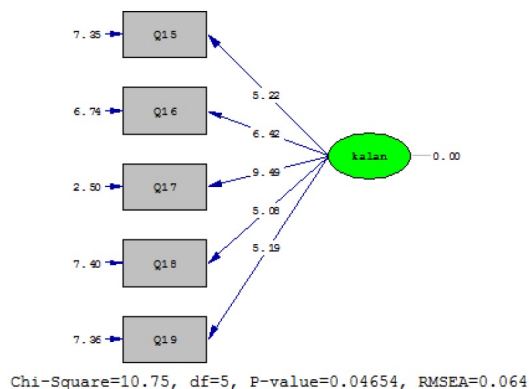

Figure 4: The model for measuring the dimensions of macroeconomic variables using factor analysis in a significant state

The diagrams in the following section show the dimensions of the capital structure model in a standard and meaningful state. As these graphs show, the membership of all investigated factors in this variable has been confirmed.

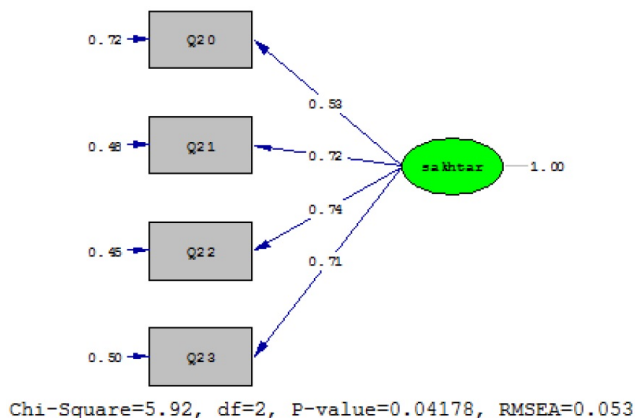

Figure 5: Measurement model of capital structure dimensions using factor analysis in standard mode

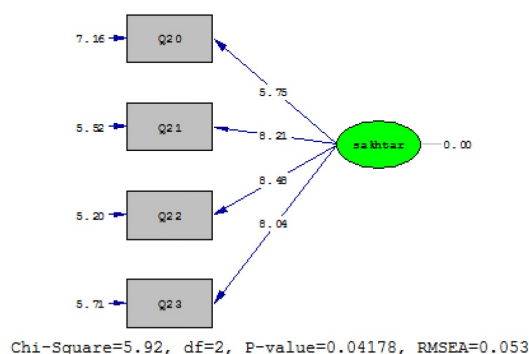

Figure 6: The measurement model of the dimensions of the capital structure using factor analysis in a significant state

(d) Capital return measurement model

The graphs in the following section show the dimensions of the capital return model in standard and meaningful mode. As these graphs show, the membership of all investigated factors in this variable has been confirmed.

5. Classification and weighting of financial restrictions

(a) Primary decision matrix

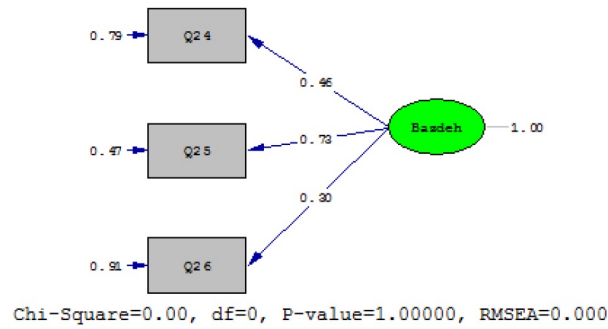

Figure 7: The model for measuring the dimensions of capital return using factor analysis in standard mode

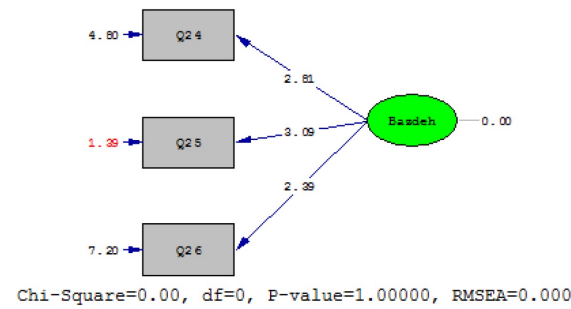

Figure 8: The model for measuring the dimensions of capital return using factor analysis in a significant state

Table 7: Primary decision matrix

Responder	Likert scale				
	1	2	3	4	5
1	5	5	5	4	5
2	5	5	5	5	5
3	4	4	4	5	5
4	5	5	5	5	5
5	5	5	5	5	4
6	5	5	5	5	5
7	4	5	4	4	5
8	5	5	5	5	4
9	5	5	5	5	5
10	5	4	5	4	5
11	5	5	5	5	5
12	4	4	4	5	5
13	5	5	5	3	5
14	5	5	5	5	5
15	5	5	5	5	5
16	4	4	4	5	4
17	5	5	5	5	5
18	4	5	5	5	5
19	5	5	5	4	5
20	4	5	4	5	5

(b) Data fuzzification

(c) Determining the value of 'D' (threshold value)

(d) Calculate the value of the structure

According to Table 10, it can be seen that most of the indicators have obtained the appropriate points and have been approved.

Table 8: Displaying data in fuzzy mode

PAKAR	SKALA FUZZY														
	1			2			3			4			5		
1	0.6	0.8	1	0.6	0.8	1	0.6	0.8	1	0.4	0.6	0.8	0.6	0.8	1
2	0.6	0.8	1	0.6	0.8	1	0.6	0.8	1	0.6	0.8	1	0.6	0.8	1
3	0.4	0.6	0.8	0.4	0.6	0.8	0.4	0.6	0.8	0.6	0.8	1	0.6	0.8	1
4	0.6	0.8	1	0.6	0.8	1	0.6	0.8	1	0.6	0.8	1	0.6	0.8	1
5	0.6	0.8	1	0.6	0.8	1	0.6	0.8	1	0.6	0.8	1	0.4	0.6	0.8
6	0.6	0.8	1	0.6	0.8	1	0.6	0.8	1	0.6	0.8	1	0.6	0.8	1
7	0.4	0.6	0.8	0.6	0.8	1	0.4	0.6	0.8	0.4	0.6	0.8	0.6	0.8	1
8	0.6	0.8	1	0.6	0.8	1	0.6	0.8	1	0.6	0.8	1	0.4	0.6	0.8
9	0.6	0.8	1	0.6	0.8	1	0.6	0.8	1	0.6	0.8	1	0.6	0.8	1
10	0.6	0.8	1	0.4	0.6	0.8	0.6	0.8	1	0.4	0.6	0.8	0.6	0.8	1
11	0.6	0.8	1	0.6	0.8	1	0.6	0.8	1	0.6	0.8	1	0.6	0.8	1
12	0.4	0.6	0.8	0.4	0.6	0.8	0.4	0.6	0.8	0.6	0.8	1	0.6	0.8	1
13	0.6	0.8	1	0.6	0.8	1	0.6	0.8	1	0.2	0.4	0.6	0.6	0.8	1
14	0.6	0.8	1	0.6	0.8	1	0.6	0.8	1	0.6	0.8	1	0.6	0.8	1
15	0.6	0.8	1	0.6	0.8	1	0.6	0.8	1	0.6	0.8	1	0.6	0.8	1
16	0.4	0.6	0.8	0.4	0.6	0.8	0.4	0.6	0.8	0.6	0.8	1	0.4	0.6	0.8
17	0.6	0.8	1	0.6	0.8	1	0.6	0.8	1	0.6	0.8	1	0.6	0.8	1
18	0.4	0.6	0.8	0.6	0.8	1	0.6	0.8	1	0.6	0.8	1	0.6	0.8	1
19	0.6	0.8	1	0.6	0.8	1	0.6	0.8	1	0.4	0.6	0.8	0.6	0.8	1
20	0.4	0.6	0.8	0.6	0.8	1	0.4	0.6	0.8	0.6	0.8	1	0.6	0.8	1
PURATA	0.536	0.736	0.936	0.564	0.764	0.964	0.555	0.755	0.955	0.545	0.745	0.945	0.564	0.764	0.964
	m1	m2	m3	m1	m2	m3	m1	m2	m3	m1	m2	m3	m1	m2	m3

Table 9: Calculate the threshold value

Responder	Structures				
	1	2	3	4	5
1	0.1	0.1	0.1	0.2	0.1
2	0.1	0.1	0.1	0.1	0.1
3	0.2	0.2	0.2	0.1	0.1
4	0.1	0.1	0.1	0.1	0.1
5	0.1	0.1	0.1	0.1	0.2
6	0.1	0.1	0.1	0.1	0.1
7	0.2	0.1	0.2	0.2	0.1
8	0.1	0.1	0.1	0.1	0.2
9	0.1	0.1	0.1	0.1	0.1
10	0.1	0.2	0.3	1.7	0.1
11	1.3	1.3	1.3	1.3	0.1
12	1.0	1.0	1.0	1.3	0.1
13	1.2	1.3	1.3	0.7	0.1
14	1.3	1.3	1.3	1.3	0.1
15	1.3	1.3	1.3	1.3	0.1
16	0.2	0.2	0.2	0.1	0.2
17	0.1	0.1	0.1	0.1	0.1
18	0.2	0.1	0.1	0.1	0.1
19	0.1	0.1	0.1	0.2	0.1
20	0.2	0.1	0.2	0.1	0.1
The value of the structure	0.386	0.400	0.428	0.431	0.091
Test value	0.192				

Table 10: The value of the structure

ITEM	1			2			3			4			5		
	JUMLAH SETIAP UNSUR	0.536	0.736	0.936	0.564	0.764	0.964	0.555	0.755	0.955	0.545	0.745	0.945	0.564	0.764
FUZZY EVALUATION	m1	m2	m3	m1	m2	m3	m1	m2	m3	m1	m2	m3	m1	m2	m3
	0.736			0.764			0.755			0.745			0.764		

- (e) Primary decision matrix
- (f) Data fuzzification

Table 11: Primary decision matrix

Responder	Likert scale													
	1	2	3	4	5	6	7	8	9	10	11	12	13	14
1	5	5	5	5	5	5	5	5	5	5	5	4	5	5
2	5	5	5	5	5	5	5	4	5	4	5	5	5	4
3	5	5	5	4	5	5	5	5	5	5	5	5	5	5
4	5	5	5	5	5	5	5	5	5	5	5	4	5	5
5	5	4	4	5	5	4	5	4	4	5	5	5	5	5
6	5	5	5	5	4	5	5	5	5	5	5	5	5	5
7	5	5	5	5	5	5	5	5	5	4	5	5	5	5
8	5	4	5	5	5	4	5	4	5	5	5	5	5	5
9	5	5	5	5	5	5	5	5	5	5	5	5	5	5
10	5	4	5	5	5	5	5	5	5	5	5	5	5	5
11	5	5	5	5	5	5	5	5	5	5	4	5	5	5
12	5	5	5	5	5	5	4	5	5	5	5	5	4	5
13	5	5	5	5	5	5	5	5	5	5	5	5	5	5
14	5	5	5	4	5	5	5	5	5	5	5	5	5	5
15	4	5	4	5	5	5	5	5	5	5	5	5	5	5
16	4	5	5	5	5	4	5	5	5	5	4	5	5	5
17	5	5	5	5	5	5	4	5	5	5	5	5	4	4
18	5	5	5	5	5	5	5	4	5	5	5	5	5	5
19	5	5	5	5	5	5	5	5	4	5	4	5	5	5
20	5	5	5	5	5	5	5	5	5	5	5	5	5	5

Table 12: Displaying data in fuzzy mode

		SKALA FUZZY																																									
		1		2		3		4		5		6		7		8		9		10		11		12		13		14															
1	0.6	0.8	1	0.6	0.8	1	0.6	0.8	1	0.6	0.8	1	0.6	0.8	1	0.6	0.8	1	0.6	0.8	1	0.6	0.8	1	0.4	0.6	0.8	0.6	0.8	1	0.6	0.8	1										
2	0.6	0.8	1	0.6	0.8	1	0.6	0.8	1	0.6	0.8	1	0.6	0.8	1	0.4	0.6	0.8	0.6	0.8	1	0.4	0.6	0.8	0.6	0.8	1	0.6	0.8	1	0.6	0.8	1	0.4	0.6	0.8							
3	0.6	0.8	1	0.6	0.8	1	0.6	0.8	1	0.4	0.6	0.8	0.6	0.8	1	0.6	0.8	1	0.6	0.8	1	0.6	0.8	1	0.6	0.8	1	0.6	0.8	1	0.6	0.8	1	0.6	0.8	1							
4	0.6	0.8	1	0.6	0.8	1	0.6	0.8	1	0.6	0.8	1	0.6	0.8	1	0.6	0.8	1	0.6	0.8	1	0.6	0.8	1	0.6	0.8	1	0.4	0.6	0.8	0.6	0.8	1	0.6	0.8	1							
5	0.6	0.8	1	0.4	0.6	0.8	0.4	0.6	0.8	0.6	0.8	1	0.6	0.8	1	0.4	0.6	0.8	0.4	0.6	0.8	0.6	0.8	1	0.6	0.8	1	0.6	0.8	1	0.6	0.8	1	0.6	0.8	1							
6	0.6	0.8	1	0.6	0.8	1	0.6	0.8	1	0.4	0.6	0.8	0.6	0.8	1	0.6	0.8	1	0.6	0.8	1	0.6	0.8	1	0.6	0.8	1	0.6	0.8	1	0.6	0.8	1	0.6	0.8	1							
7	0.6	0.8	1	0.6	0.8	1	0.6	0.8	1	0.6	0.8	1	0.6	0.8	1	0.6	0.8	1	0.6	0.8	1	0.6	0.8	1	0.4	0.6	0.8	0.6	0.8	1	0.6	0.8	1	0.6	0.8	1							
8	0.6	0.8	1	0.4	0.6	0.8	0.6	0.8	1	0.6	0.8	1	0.4	0.6	0.8	0.4	0.6	0.8	0.6	0.8	1	0.4	0.6	0.8	0.6	0.8	1	0.6	0.8	1	0.6	0.8	1	0.6	0.8	1							
9	0.6	0.8	1	0.6	0.8	1	0.6	0.8	1	0.6	0.8	1	0.6	0.8	1	0.6	0.8	1	0.6	0.8	1	0.6	0.8	1	0.6	0.8	1	0.6	0.8	1	0.6	0.8	1	0.6	0.8	1							
10	0.6	0.8	1	0.4	0.6	0.8	0.6	0.8	1	0.6	0.8	1	0.6	0.8	1	0.6	0.8	1	0.6	0.8	1	0.6	0.8	1	0.6	0.8	1	0.6	0.8	1	0.6	0.8	1	0.6	0.8	1							
11	0.6	0.8	1	0.6	0.8	1	0.6	0.8	1	0.6	0.8	1	0.6	0.8	1	0.6	0.8	1	0.6	0.8	1	0.6	0.8	1	0.4	0.6	0.8	0.6	0.8	1	0.6	0.8	1	0.6	0.8	1							
12	0.6	0.8	1	0.6	0.8	1	0.6	0.8	1	0.6	0.8	1	0.6	0.8	1	0.4	0.6	0.8	0.6	0.8	1	0.6	0.8	1	0.6	0.8	1	0.4	0.6	0.8	0.6	0.8	1	0.6	0.8	1							
13	0.6	0.8	1	0.6	0.8	1	0.6	0.8	1	0.6	0.8	1	0.6	0.8	1	0.6	0.8	1	0.6	0.8	1	0.6	0.8	1	0.6	0.8	1	0.6	0.8	1	0.6	0.8	1	0.6	0.8	1							
14	0.6	0.8	1	0.6	0.8	1	0.6	0.8	1	0.4	0.6	0.8	0.6	0.8	1	0.6	0.8	1	0.6	0.8	1	0.6	0.8	1	0.6	0.8	1	0.6	0.8	1	0.6	0.8	1	0.6	0.8	1							
15	0.4	0.6	0.8	0.6	0.8	1	0.4	0.6	0.8	0.6	0.8	1	0.6	0.8	1	0.6	0.8	1	0.6	0.8	1	0.6	0.8	1	0.6	0.8	1	0.6	0.8	1	0.6	0.8	1	0.4	0.6	0.8							
16	0.4	0.6	0.8	0.6	0.8	1	0.6	0.8	1	0.6	0.8	1	0.4	0.6	0.8	0.6	0.8	1	0.6	0.8	1	0.6	0.8	1	0.6	0.8	1	0.4	0.6	0.8	0.6	0.8	1	0.6	0.8	1							
17	0.6	0.8	1	0.6	0.8	1	0.6	0.8	1	0.6	0.8	1	0.6	0.8	1	0.4	0.6	0.8	0.6	0.8	1	0.6	0.8	1	0.6	0.8	1	0.6	0.8	1	0.4	0.6	0.8	0.4	0.6	0.8							
18	0.6	0.8	1	0.6	0.8	1	0.6	0.8	1	0.6	0.8	1	0.6	0.8	1	0.6	0.8	1	0.4	0.6	0.8	0.6	0.8	1	0.6	0.8	1	0.6	0.8	1	0.6	0.8	1	0.6	0.8	1							
19	0.6	0.8	1	0.6	0.8	1	0.6	0.8	1	0.6	0.8	1	0.6	0.8	1	0.6	0.8	1	0.4	0.6	0.8	0.6	0.8	1	0.4	0.6	0.8	0.6	0.8	1	0.6	0.8	1	0.6	0.8	1							
20	0.6	0.8	1	0.6	0.8	1	0.6	0.8	1	0.6	0.8	1	0.6	0.8	1	0.6	0.8	1	0.6	0.8	1	0.6	0.8	1	0.6	0.8	1	0.6	0.8	1	0.6	0.8	1	0.6	0.8	1							
		0.582	0.782	0.982	0.584	0.784	0.984	0.582	0.782	0.982	0.573	0.773	0.973	0.582	0.782	0.982	0.573	0.773	0.973	0.584	0.784	0.984	0.584	0.784	0.984	0.573	0.773	0.973	0.582	0.782	0.982	0.573	0.773	0.973	0.582	0.782	0.982	0.582	0.782	0.982	0.573	0.773	0.973
		m1	m2	m3	m1	m2	m3	m1	m2	m3	m1	m2	m3	m1	m2	m3	m1	m2	m3	m1	m2	m3	m1	m2	m3	m1	m2	m3	m1	m2	m3	m1	m2	m3	m1	m2	m3	m1	m2	m3	m1	m2	m3

- (g) Determine the value of 'D' (threshold value)
- (h) Calculate the value of the structure

### 5 Conclusion

In the current research, firstly, by following Kaplan Zingales and White and Wu research models, the indicators of primary financial limitations were identified and provided to the experts. The experts first confirmed the research indicators of the Kaplan Zingales and White and Wu models and then added a series of indicators to these indicators.

Table 13: Calculate the threshold value

Responder	Structures													
	1	2	3	4	5	6	7	8	9	10	11	12	13	14
1	0.0	0.1	0.0	0.0	0.0	0.0	0.1	0.1	0.0	0.0	0.0	0.3	0.0	0.0
2	0.0	0.1	0.0	0.0	0.0	0.0	0.1	0.2	0.0	0.3	0.0	0.0	0.0	0.3
3	0.0	0.1	0.0	0.3	0.0	0.0	0.1	0.1	0.0	0.0	0.0	0.0	0.0	0.0
4	0.0	0.1	0.0	0.0	0.0	0.0	0.1	0.1	0.0	0.0	0.0	0.3	0.0	0.0
5	0.0	0.2	0.3	0.0	0.0	0.3	0.1	0.2	0.3	0.0	0.0	0.0	0.0	0.0
6	0.0	0.1	0.0	0.0	0.3	0.0	0.1	0.1	0.0	0.0	0.0	0.0	0.0	0.0
7	0.0	0.1	0.0	0.0	0.0	0.0	0.1	0.1	0.0	0.3	0.0	0.0	0.0	0.0
8	0.0	0.2	0.0	0.0	0.0	0.3	0.2	0.1	0.3	0.0	0.0	0.0	0.0	0.0
9	0.0	0.1	0.0	0.0	0.0	0.0	0.1	0.1	0.0	0.0	0.0	0.0	0.0	0.0
10	0.1	1.2	1.3	1.7	0.0	0.0	0.1	0.1	0.0	0.0	0.0	0.0	0.0	0.0
11	1.3	1.3	1.3	1.3	0.0	0.0	0.1	0.1	0.0	0.0	0.3	0.0	0.0	0.0
12	1.3	1.3	1.3	1.3	0.0	0.0	0.2	0.1	0.0	0.0	0.0	0.0	0.3	0.0
13	1.2	1.3	1.3	1.3	0.0	0.0	0.1	0.1	0.0	0.0	0.0	0.0	0.0	0.0
14	1.3	1.3	1.3	1.0	0.0	0.0	0.1	0.1	0.0	0.0	0.0	0.0	0.0	0.0
15	1.3	1.3	1.0	1.3	0.0	0.0	0.1	0.1	0.0	0.0	0.0	0.0	0.0	0.3
16	0.3	0.1	0.0	0.0	0.0	0.3	0.1	0.1	0.0	0.0	0.3	0.0	0.0	0.0
17	0.0	0.1	0.0	0.0	0.0	0.0	0.2	0.1	0.0	0.0	0.0	0.0	0.3	0.3
18	0.0	0.1	0.0	0.0	0.0	0.0	0.1	0.2	0.0	0.0	0.0	0.0	0.0	0.0
19	0.0	0.1	0.0	0.0	0.0	0.0	0.1	0.1	0.3	0.0	0.3	0.0	0.0	0.0
20	0.0	0.1	0.0	0.0	0.0	0.0	0.1	0.1	0.0	0.0	0.0	0.0	0.0	0.0
The value of the structure	0.331	0.423	0.379	0.416	0.050	0.072	0.091	0.091	0.072	0.050	0.072	0.050	0.050	0.072
Test value	0.168													

Table 14: The value of each structure

ITEM	1			2			3			4			5			6			7			8		
JUMLAH SETIAP UNSUR	0.582	0.782	0.982	0.564	0.764	0.964	0.582	0.782	0.982	0.573	0.773	0.973	0.582	0.782	0.982	0.573	0.773	0.973	0.564	0.764	0.964	0.564	0.764	0.964
	m1	m2	m3	m1	m2	m3	m1	m2	m3	m1	m2	m3	m1	m2	m3	m1	m2	m3	m1	m2	m3	m1	m2	m3
FUZZY EVALUATION	0.782			0.764			0.782			0.773			0.782			0.773			0.764			0.764		
ITEM	9			10			11			12			13			14								
JUMLAH SETIAP UNSUR	0.573	0.773	0.973	0.582	0.782	0.982	0.573	0.773	0.973	0.582	0.782	0.982	0.582	0.782	0.982	0.573	0.773		0.973					
	m1	m2	m3	m1	m2	m3	m1	m2	m3	m1	m2	m3	m1	m2	m3	m1	m2	m3						
FUZZY EVALUATION	0.773			0.782			0.773			0.782			0.782			0.773								

The results of these analyzes have been carried out in the form of fuzzy Delphi technique to confirm the structures, as well as the exploratory analysis technique in order to categorize the indicators. In the following, the results related to each of the goals are presented.

In this research, in order to identify the financial constraints, the fuzzy Delphi technique has been used, organizational financial constraints by studying the literature and using the opinion of experts in different stages of the implementation of the technique in the form of the dimensions of the dividend ratio, cash flow, interest coverage, index ww and kz index were introduced. Finally, using the results obtained from the implementation of the fuzzy Delphi technique, indicators related to financial constraints were identified in 4 stages. In order to test the hypotheses, the structural equation technique was used. In the following, the effect of each of these financial restrictions on the required indicators was introduced. It is explained.

In this research, it was claimed that macroeconomic variables mediate the relationship between financial constraints and the capital structure of the companies under investigation, which the statistical analysis between the two shows, the significant number of the path between the two variables is greater than 1.96. Therefore, this hypothesis is confirmed. On the other hand, since the obtained significant number is positive, this effect is direct.

It was also claimed that macroeconomic variables mediate the relationship between financial constraints and stock returns of the companies under investigation, which statistical analysis between the two shows, the significant number of the path between the two variables is greater than 1.96, from Therefore, this hypothesis is confirmed.

Table 15: List of final indicators

Final indicators
Cash flow and short-term investment
Changes in the company's liabilities and assets
The ratio of the market value to the book value of the company
Dividends on assets
Debt-to-asset ratio
Cash balance
Supplying resources through internal company resources
Failure to acquire new assets
Failure to invest in new business activities
Reduced dividend payments
Maintaining a certain level of working capital
The sum of operating profit and depreciation
Research and development costs
Change in non-cash assets
High participation of research staff in the organization

## References

- [1] Z. Ahmad, N.M.H. Abdullah and S. Roslan, *Capital structure effect on firms performance: Focusing on consumers and industrials sectors on Malaysian firms*, Int. Rev. Bus. Res. Papers **8** (2013), no. 5, 137–155.
- [2] Z. Ahmed and D.T. Tinhala, *Stock return volatility and capital structure measures of nonfinancial firms in a dynamic panel model: Evidence from Pakistan*, Int. J. Finance Econ. **24** (2019), no. 1, 604–628.
- [3] W.A. Al Salamat and H.H. Mustafa, *The impact of capital structure on stock return: Empirical evidence from Amman stock exchange*, Int. J. Bus. Soc. Sci. **7** (2016), no. 9, 183–196.
- [4] A.M. Ansari, Z. Zare and N. Yusufzadeh, *Simultaneous investigation of factors affecting the capital structure and stock returns in companies listed on the Tehran stock exchange*, Account. Audit. Res. **25** (2014).
- [5] B. Asghranejad Nouri, *Effective factors in stock returns of companies listed on the Tehran stock exchange: A meta-analysis approach*, Asset Manage. Financ. **6** (2017), no. 1, 29–50.
- [6] N.W. Cahyaningtyas and H. Muharam, *Determinants of capital structure and firm financial performance: empirical evidence on food and beverage sector in Indonesian listed companies*, Acad. Account. Financ. Stud. J. **26** (2022), 1–10.
- [7] T. Chandra, A.T. Junaedi, E. Wijaya, S. Suharti, I. Mimelientesa, and M. Ng, *The effect of capital structure on profitability and stock returns: Empirical analysis of firms listed in Kompas 100*, J. Chinese Econ. Foreign Trade Stud. **12** (2019), no. 2, 74–89.
- [8] H. Cuevas-Vargas, H.A. Cortés-Palacios, and J.J. Lozano-García, *Impact of capital structure and innovation on firm performance, direct and indirect effects of capital structure*, Procedia Comput. Sci. **199** (2022), 1082–1089.
- [9] J.K. dan Perbankan, *The effect of firm profitability on expected stock return in ASEAN stock market*, J. Keuangan d Perbankan **25** (2021), no. 3, 642–655.
- [10] S. Darvishi, *Investigating the impact of financial restrictions and financial development on the relationship between future investment and stock liquidity in companies listed on the Tehran stock exchange*, 8th Nat. Conf. Econ. Manag. Account., Shirvan, 2021.
- [11] M.S. Fombang and C.K. Adjasi, *Access to finance and firm innovation*, J. Financ. Econ. Policy **10** (2018), no. 1, 73–94.
- [12] J. García-Quevedo, A. Segarra-Blasco, and M.M. Teruel, *Financial constraints and the failure of innovation projects*, Technol. Forecast. Soc. Change **127** (2018), 127–140.
- [13] M.S. Hakim, V. Oktavianti and I.K. Gunarta, *Determining factors that contribute to financial literacy for small and medium enterprises*, IOP Conf. Ser.: Materials Sci. Eng. IOP Pub. **337** (2018), no. 1, 012064.
- [14] S.A. Hashemi, S. Samadi, and T. Sarkissian, *Investigating the interrelationship of factors affecting the capital structure and stock returns of companies listed in the Tehran stock exchange*, Stock Exchange **5** (2011), no. 17, 43–62.

- [15] H. Hassanzadeh Bijarkani and M. Nurbakhsh Langroudi, *Capital structure and stock returns in companies listed on Tehran stock exchange*, Third Nat. Engin. Manag. Conf., Astane Ashrafiyeh, 2017.
- [16] S. Malamud and F. Zucchi, *Liquidity, innovation, and endogenous growth*, J. Financ. Econ. **132** (2019), no. 2, 519–541.
- [17] V.V.E. Mettelskaya, *Correlation-and-regression analysis of the influence of macroeconomic factors on capital structure of Russian corporations under crisis conditions*, J. Innov. Entrepr. **10** (2021), no. 1, 1–34.
- [18] S.M. Mirlohi, M. Tehrani, S.A. Lotfi and M. Kostin Roudi, *Investigating the capital structure and its effect on the stock returns of companies listed on the Tehran stock exchange*, Financ. Econ. Policy Quart. **5** (2016), no. 20, 173–196.
- [19] H.H. Mohammad, *The effect of capital structure on stock returns at Nairobi securities exchange: A sectoral analysis*, Doctoral dissertation, University of Nairobi, 2017.
- [20] K.H. Park, J. Byun and P.M.S. Choi, *Managerial overconfidence, corporate social responsibility activities, and financial constraints*, Sustainability **12** (2019), no. 1, 61.
- [21] M. Pourali, Y. Rajaei and M. Dalmanpour, *Effects of macroeconomic and institutional variables on the economic growth of selected developing countries*, Appl. Econ. **10** (2019), no. 32 and 33, 79–96.
- [22] H. Rezai Dolatabadi, F. Amiri Eghdai, B. Rifat and F. Izadi, *The effectiveness of the relationship between capital structure and financial performance of companies from product market competition and the type of business strategy of companies*, Financ. Manage. Strat. **2** (2013), no. 1, 39–58.
- [23] F. Sukesti, I. Ghazali, F.U.A.D. Fuad, A.K. Almasryhari and N. Nurcahyono, *Factors affecting the stock price: The role of firm performance*, J. Asian Finance, Econ. Bus. **8** (2021), no. 2, 165–173.
- [24] N.H. Wellalage and V. Fernandez, *Innovation and SME finance: Evidence from developing countries*, Int. Rev. Financ. Anal. **66** (2019), 101370.